

Middle Atlantic Products

EXCEPTIONAL SUPPORT & PROTECTION™

EIA/TIA Compliant
SEISMIC CERTIFIED
C(UL)US LISTED

WRK Series Enclosure

The WRK Series 19" gangable enclosure accommodates large cable bundles

Features

- Fully welded construction provides the following weight capacities - UL Listed load capacity: 2,500 lbs - Static load capacity: 10,000 lbs. - Seismic certified load capacity: 900 lbs.
- 1/8" thick structural steel internal braces
- 24-1/4" OD width, available 27-5/8" or 32-5/8" OD depth
- 1/2", 3/4", 1" & 1-1/2" electrical knockouts on split rear plates top & bottom, easily removable for cable pass-through, top plates additionally include UHF / VHF knockouts
- 2 extra-wide pairs of 11-gauge 10-32 threaded rackrail with numbered rackspace increments
- Optional solid, fully vented, plexi & vented plexi doors
- Open top with configurable top panel options
- Durable black textured powder coat finish
- Seismic certified (when used with WRK-Z4 option) with an Ip value of 1.5
- UL Listed in the US and Canada



WRK-44-32

Enclosure Accessories

ADDITIONAL RACKRAIL KIT
 CASTER BASE
 COPPER BUSS BAR
 CRATING SERVICE
 DOCUMENT POCKET
 DOOR LATCH
 GANGING HARDWARE
 INNER PLATFORM BASE
 LEVELING FEET
 TOUCH-UP PAINT
 SEISMIC FLOOR ANCHOR BRACKETS
 CONFIGURABLE TOPS
 TOP RAILS
 UNIVERSAL FRONT DOORS
 UNIVERSAL VENTED REAR DOORS
 for details - see Master Catalog or visit middleatlantic.com

Architects' and Engineers' Specifications

EIA compliant 19" gangable equipment rack shall be Middle Atlantic Products model # WRK-___ (see chart for available models). Overall dimensions of rack shall be ___" H x 24-1/4" W x ___" D (refer to chart). Useable height shall be ___ rackspace, useable depth shall be ___" (refer to chart). Fully welded construction shall provide a static load capacity of 10,000 lbs. and a UL Listed 2,500 lb. weight capacity. Rack shall be constructed of the following materials: top and bottom shall be 14-gauge steel, horizontal braces shall be 16-gauge steel welded to integral structural side panels of 16-gauge steel giving an 1/8" thick structure, all structural elements shall be finished in a durable black powder coat. Rack shall include locking, latching rear door. Rack shall come equipped with two pairs of 11-gauge steel rackrail with tapped 10-32 mounting holes in universal EIA spacing. Finished in black e-coat with numbered rackspace. Top and bottom of rack shall have a vertical slotted vent pattern. Rack shall have removable split rear knockout panels with 1/2", 3/4", 1", and 1-1/2" electrical knockouts installed in base, and removable split rear knockout panels with 1/2", 3/4", 1", and 1-1/2" electrical knockouts, and BNC knockouts for UHF/VHF antennae installed in top. Grounding and bonding stud shall be 1/4-20 threaded, installed in base of enclosure. WRK Series enclosures shall satisfy the 2007 & 2010 CBC; 2006, 2009 & 2012 IBC; ASCE 7-05 (2005 Edition) & ASCE 7-10 (2010 Edition) and the 2006 & 2009 editions of NFPA 5000 for use in areas of high seismicity, Seismic Use Group III, Zone 4 or Seismic Design Category (SDC) "D" with lateral force requirements for protecting 900 lbs. of essential equipment in locations with the highest level of seismicity and top floor or rooftop installations with an Importance factor (Ip) of 1.5 when used with WRK-Z4 seismic floor anchor bracket. Rack shall be UL Listed in the US and Canada. Rack shall be GREENGUARD Indoor Air Quality Certified for Children and Schools. Rack shall be RoHS EU Directive 2002/95/EC compliant. Rack shall be manufactured by an ISO 9001 and ISO 14001 registered company. Rack shall be warranted to be free from defects in material or workmanship under normal use and conditions for the lifetime of the rack.

OPTIONS

- Front doors shall be 16-gauge reinforced steel, model # FD-XX (solid), VFD-XX (vented, 25% open area), LVFD-XX (vented, 64% open area), PFD-XX (plexi), PVFD-44 (vented plexi) (X=# of rackspace of WRK rack)
- Vented rear doors shall be 16-gauge steel model # MW-VRD-44 (vented, top and bottom), MW-LVRD-XX (vented 64% open area-excludes 24 and 37 space rack), (X=# of rackspace of WRK rack), MW-CLVRD-44 (split rear door, vented, 79% open area)
- Removable keylocked side panels shall be model # SPN-XX-YY (X = # of rackspace, Y = cabinet depth)
- Top panels multiple styles available in model # MW-ST (solid), #MW-10FT (10" fan), MW-4FT (four 4-1/2" fans), MW-6FT (three 6" fans), MW-VT (vented) and MW-LA (accepts 6" & 12" wide cable ladders) see A&E spec 96-01063 for more details
- Caster base, four casters shall have a total weight capacity of 1300 lbs, model # CBS-WRK-YY (Y= cabinet depth)
- Inner platform base (inset base w/out casters) model # BS-WRK-YY (Y= cabinet depth)
- Leveling feet model # LF, shall be 3/8" threaded steel, adjustable from top or bottom, adds 1/4" min. to 1" max. to rack overall height
- Additional rail kit, 11-gauge, 10-32 threaded, sold in pairs, hardware included, model # WRK-RRXX (X= # of rackspace)
- AXS slide out option available (See AXS Spec sheet 96-052S)

CUSTOMIZABLE SPECIFICATION CLIPS AVAILABLE AT MIDDLEATLANTIC.COM

WRK basic dimensions

REAR VIEW, TOP & BOTTOM

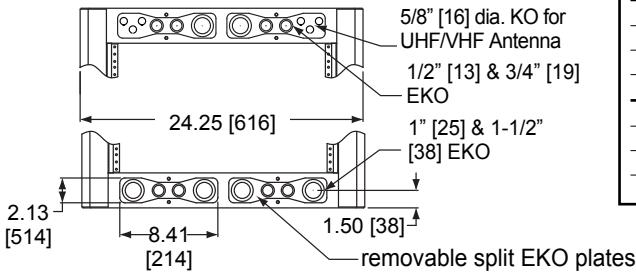

Part #	A OVERALL HEIGHT	B USEABLE HEIGHT	C OVERALL DEPTH	D USEABLE DEPTH	E BASE OPENING DEPTH
WRK-44-27	83.13 [2111]	77.13 [1959]	27.63 [702]	25.75 [654]	24.50 [622]
WRK-40-27	76.13 [1934]	70.13 [1781]	27.63 [702]	25.75 [654]	24.50 [622]
WRK-37-27	70.88 [1800]	64.88 [1648]	27.63 [702]	25.75 [654]	24.50 [622]
WRK-24-27	48.13 [1222]	42.13 [1070]	27.63 [702]	25.75 [654]	24.50 [622]
WRK-44-32	83.13 [2111]	77.13 [1959]	32.63 [829]	30.75 [781]	29.50 [749]
WRK-40-32	76.13 [1934]	70.13 [1781]	32.63 [829]	30.75 [781]	29.50 [749]
WRK-37-32	70.88 [1800]	64.88 [1648]	32.63 [829]	30.75 [781]	29.50 [749]
WRK-24-32	48.13 [1222]	42.13 [1070]	32.63 [829]	30.75 [781]	29.50 [749]

REAR VIEW

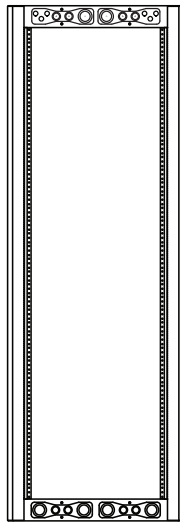

SIDE VIEW

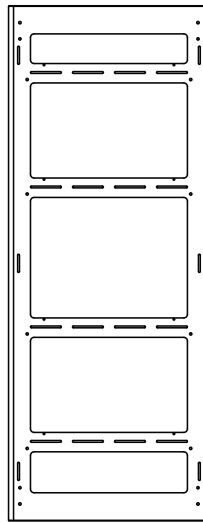

FRONT VIEW

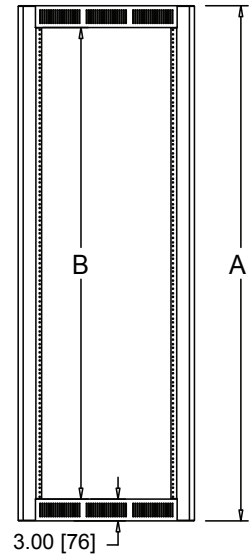

TOP SIDE SECTIONAL VIEW

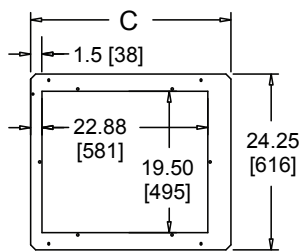
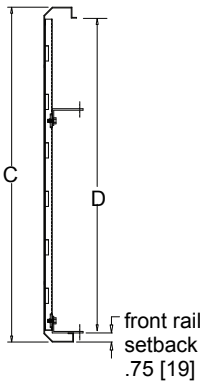

TOP VIEW

1/4 - 20 x 1" [25.40] grounding and bonding stud (1 place only)

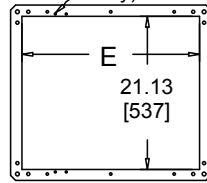

BOTTOM VIEW

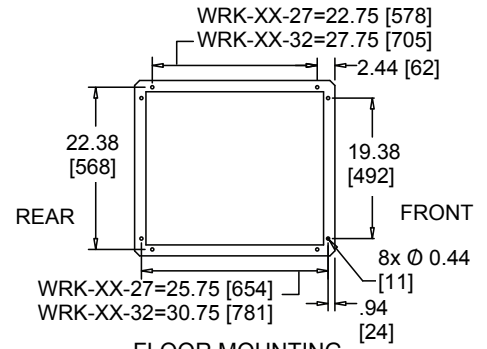

FLOOR MOUNTING LOCATIONS

All dimensions in inches unless otherwise noted [All dimensions in brackets are in millimeters]



TOP OPTIONS

(removable plate opening accommodates 2 space panel)

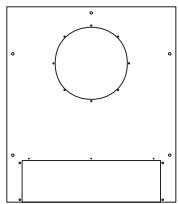

MW-10FT accepts 10" fan
MW-10FT-550CFM includes 10" fan
MW-10FT-FC includes 10" fan and fan controller

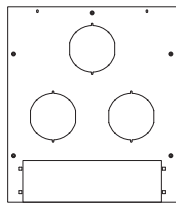

MW-6FT accepts 6" fans
MW-6FT-660CFM includes 6" fans

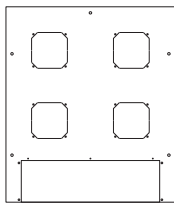

MW-4FT accepts 4-1/2" fans
MW-4FT-380CFM includes 4-1/2" fans
MW-4QFT-FC includes 4-1/2" quiet fans and fan controller

accommodates 12" and 6" width cable ladders

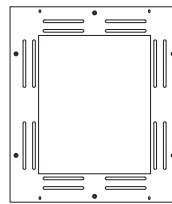

MW-LA accepts 6", 9" and 12" width cable ladder

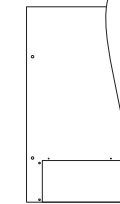

MW-ST solid

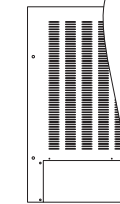

MW-VT slot vent

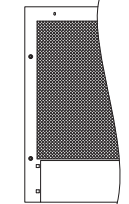

MW-LVT 64% open area